

MODEL FX-900



FX-900 Specifications

Airflow	900 cfm
Fits machines with enclosure volume of:	90–180 cubic feet
Motor	3 HP, 3-Phase, 50/60 Hz. Voltage & Current @ 60Hz. 208V – 8.8A 230V – 8.2A 460V – 4.1A
Weight	51 lbs.
Noise Level	70 dBA
Inlet Diameter	6"

Mounting Options — FX-900

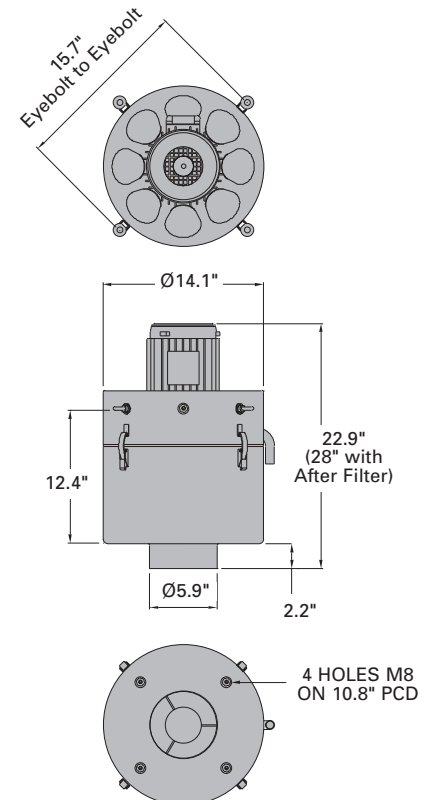

Direct Mount	use 30302 — FX-900 Direct Mount Kit
Floor Stand	use 30315 — Floor Stand "B"
Machine Top Stand	use 30314 — Machine Stand "B"
Wall Mount	use 30320 — Wall Bracket "B"
Machine Side Mount	N/A
Suspended	use 30310 — Suspension Kit "B"

- For use on enclosed machines with an internal volume between 90 cu. ft. and 180 cu. ft.
- **Popular for open machines** requiring a Y-junction and two intake points.
- Unit can be mounted directly to the machine, on stands, on brackets, or suspended.



MODEL FX-900

Filtermist Units

Description	Cat. No.	Price
 FX-900 Filtermist Unit Order performance and mounting accessories separately.	30120	\$2,440
 FX-900 Stainless Steel Unit See page 134 for additional information.	30160	\$3,860













Electrical Accessories

Description	Cat. No.	Price
 Starter Box Kit Includes NEMA 12 box, IEC motor starter, 20 ft. of input cable, 15 ft. of output cable with turn-lock connector	FX-900 & 1200 Low-Voltage (208/230V)	30472 \$429
	FX-900 & 1200 High Voltage (460V)	30473 \$429

Performance Accessories

Description	Cat. No.	Price
 After Filter "B" Used for collecting dry smoke and very fine mist particles.	30205	\$261
 Cyclonic Swarf Separator For use on applications such as grinding and cast iron machining where very fine solid particles are entrained in the mist stream. Also acts as a great pre-filter for high pressure coolant applications.	30210	\$664
 Chip Deflector "B" Protects intake from coolant splash and chips.	30220	\$46

Mounting Accessories

Description	Cat. No.	Price
 Direct Mount Kit (FX-900) Includes 6" collar seal, set of rigid mounting studs, and hardware.	30302	\$66
 Floor Stand "B" Adjusts from 6 ft. to 9 ft. Bolts to floor for safety.	30315	\$695
 Machine Top Stand "B" 3 ft. tall stand bolts to the top of a machine.	30314	\$365
 Wall Bracket "B" Can be used to mount unit to a wall or other suitable mounting surface.	30320	\$245
 Suspension Kit "B" Includes 30 ft. of chain, 4 eyebolts, 8 split links, and 1 adjustable link.	30310	\$104
 Oil Return Hose 3/4" diameter.	30335	\$3 per ft.
 Ducting Flexible vinyl with heavy wire support.	8" 30344 6" 30342 4" 30340	\$12 per ft. \$9 per ft. \$8 per ft.
Warning — never use sheetmetal ducting or any other type that could leak and cause a hazardous condition.		
 Hose Clamps For securing ducting to accessories.	8" 30354 6" 30352 4" 30350	\$5 \$5 \$4
 Y-Junctions For multiple pickup locations.	A B 8" 6" 30368 8" 4" 30366 6" 6" 30364 6" 4" 30362 4" 4" 30360	\$243 \$300 \$223 \$214 \$175
 Flange Adapters For securing ducting directly to an enclosed machine.	8" 30374 6" 30372 4" 30370	\$52 \$50 \$48
 Reducers	A B 8" 6" 30382 6" 4" 30380	\$92 \$92
 Fishtails For use on open machines.	A B 8" 11.75" x 5" 30394 6" 10" x 4.5" 30392 4" 8.25" x 3.5" 30390	\$175 \$158 \$146